

HZ2376

Single Phase Contact Resistance Tester



Dear user:

Thank you for choosing HZ2376 Single Phase Contact Resistance Tester.

We hope that this instrument can make your work easier and more enjoyable, so that you can get the feeling of office automation in the test and analysis work.

Before using the instrument, please read this manual, and operate and maintain the instrument according to the manual to prolong its service life. "Just a light press, the test will be completed automatically" is the operating characteristics of this instrument.

If you are satisfied with this instrument, please tell your colleagues; if you are not satisfied with this instrument, please call (0312) 6775511 to tell you to serve you at all times-Baoding Huazheng Electric Manufacturing Co., Ltd., our company will definitely make you satisfied!

Contents

I.Description	1
II.Product Features	1
III.Technical Parameters	3
IV.Operating Principle	4
V.Panel Description and Wire Connection	4
VI.Operating Procedure	5
VII.DC Constant Current Source Function	12
VIII.Mobile Phone Control and Data Transfer (BT communication)	12
IX.Failure Analysis and Trouble Shooting	14
X.Attentions	14
XI.Transportation and Storage	14

I.Description

Single Phase Contact Resistance Tester is made and contained of advanced high-power switching power supply technology and advanced electronic circuit. It is the dedicated tester for the resistance of high and low switch, cable wire and welding joint. Its current uses national standard GB736 recommended standard DC, can measure the resistance value of being tested object under standard current status. The tester is small dimension, light weight, strong anti-interference, high precision, easy operation and perfect function protection and so on.

II.Product Features

1.Color Touch Screen: 800*480 high resolution color 7" touch screen, user interactive interface, high-speed thermal printer.

2.Large-range current output: Adopt the latest power supply technology, long time continuously output big current, large-range current output. Can set 1 to 3 different current range for testing, and automatically calculate average value.

3.Digital displaying data information : Resistance, voltage, current, electrical resistivity, resistance values at converted standard temperatures.

4.Auto-alarm of over limit: Set resistance up-limit value of pass / over limit / invalid, automatically generate testing status.

5.Long-time testing: Can set test time from 0-9999s and support long-time working. Inside cold-wind heat dissipation, switch power automatically protection.

6.High-precision measurement: Use Operational amplifiers from precision instruments and High precision quadruple integral A/D converter.

7.Latest System IC : Use High performance 32-bit latest ARM chips, System automatically switch magnification times based on signal, ensure testing precision.

8.Inside Calendar & Clock: provide accurate time of testing and printing.

9.DC constant current source function: Can output current from 0 to infinite value, built-in current step-by-step up-flow test, equal to another powerful DC constant current source for test.

10. Large-volume testing record storage: Build-in large capacity storage for look up, also have data protection function while power shut down suddenly.

11. Removable USB flash drive data access: Expert word file data record.

12. Standard Modbus-RTU: Build-in RS232 port (customized convert to RS485), communication protocol Modbus-RTU.

13. Blue tooth control and upload data: Standard configuration blue tooth function, build-in android BT APP for data control / upload / generate word file.

14.Convenient cable operating: Cable control mode (customized), set cable control

switch to regulate open / touch, test / interruption, light-alarm for resistance output over limit.

14.Quick and convenient wireless remote controller: it is customized, with one button operation of testing and interruption, customized controller can show the test progress.

15.Temperature offset automatically calculate resistance: Can preset temperature, automatically calculate resistance in standard temperature. Also use temperature sensor (customized) to measure.

16.Background color change: Set background color to blue and graphic black, brightness, standby brightness and time.

17.Build-in training material: Document shows the cable connecting method for onsite guidance.

18. input test information: Key in test spot, equipment, person, remark etc, convenient to remark and store test data and printing.

19. Big current cable quick connection: Use latest big current cable port, insert and turn lock up.

III. Technical Parameters

Selection	100A	200A	300A	400A	500A	600A	10-5000 A
Measurement range	100A customized	100A 200A customized	100A 200A 300A customized	100A 200A 300A 400A customized	100A 200A 300A 400A 500A customized	100A 200A 300A 400A 500A 600A customized	Current customized, 1, two-phase, 2, three-phase
Test range	0~19999μΩ expandable						
Test precision	0.5%rdg±10dgt						
Resolution	0.01μΩ						
Working power	AC 220V±10% 50Hz±2%						
Length(mm)	450	450					
Width(mm)	250	250					

)							
Height(m m)	220	280					
Weight(Kg)	9.9	12.9					
Environm ent temperatu re	-25°C ~50°C						
RH	≤90%RH						

IV.Operating Principle

Intelligent Circuit Resistance Tester adopts current and voltage method test principle, also called four-wire test technology, principle shows as below picture 1.

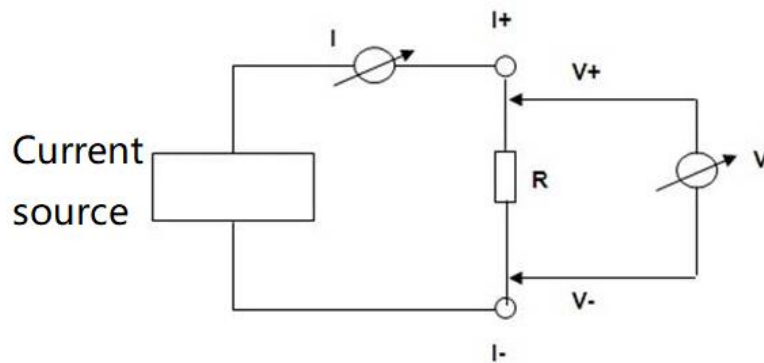

Picture 1, Test Principle

Current source have two-end“I+、 I- (called ‘I’ shape), supply current for being tested resistance Rx, current value can be read by amperemeter I, voltage of Rx“V+、 V-” (called ‘V’ shape) read by voltmeter V. So to calculate resistance value by the measurement of I and V.

V.Panel Description and Wire Connection



Picture 2

Picture 2 shows the reference of single-phase tester, please refer to real object.

Three-phase tester is totally different.

GND: Connecting with land grounding.

Power socket: Input AC220V power, switch, fuse inside, light indicator inside switch.

Cable connecting point: There have four posts, outer side are two bigger posts connecting with current cable, inner side are two smaller posts connecting with voltage (cable wire), please connect cable matching with red / black / big / small indication, red is positive, black is negative.

Three-phase connecting post is separately for A,B and C, A is yellow, B is green, C is red.

Touch color screen: 800*480 pixel dot matrix touch color LCD screen, very visible under sunshine and dark environment.

Thermal printer: Build-in a thermal printer in the tester. Thermal paper can be used for data printing on one side, can not on the other side. Only around three months recording on the thermal paper, can not used for long time storage.

RS232 port: RS232 is a serial communication interface port, normal configuration is RS232 (customized RS485). Communication protocol is Modbus-RTU(9600-N-1), please contact us if need because it is not provided align with product shipment.

USB: It is removable U storage connecting port, but can not connect and communicate with computer, also export test data.

GPI: GPI port connects with temperature sensor, also used for external cable and alarm light.

Attentions: There have some tips and cable connection diagram.

Bluetooth: Bluetooth connects with computer for communication. Contact with us for BT APP requirement, not provided with product shipment.

VI. Operating Procedure

Normal operating process is shutdown cable connection, power on, settings, test, data storage, printing, shutdown and remove cable, totally it is 7-setp.

(1) Cable connection

Under shutdown status, please connect GND cable, power cable, test cable. Refer to the cable connection diagram in 'help' menu. Tighten the big current clamp, small current clamp must tight touch with being tested object, two small voltage clamps are in inner side of current clamp.

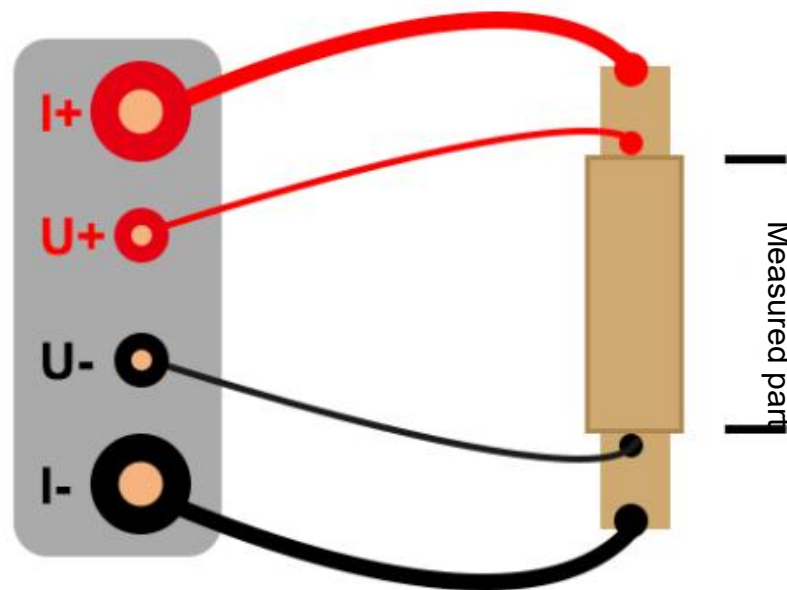

Picture 3

(2) Power on

After power on, refer to the diagram showing as picture 4.

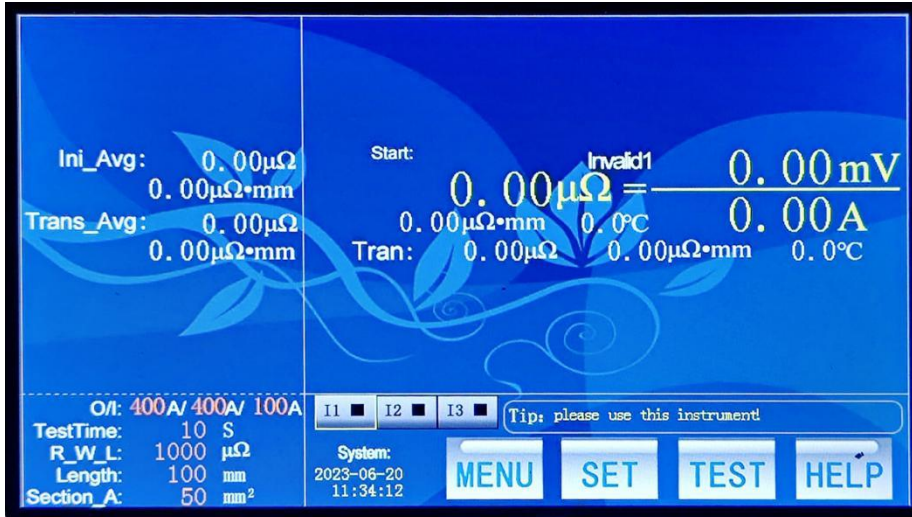

Picture 4, main interface

Right up zone: 1st row shows test status (pass / over limit / invalid). Middle side large letter shows resistance, voltage and current. 3rd row shows actual test resistivity and actual temperature. Next row shows converting data as converted resistance, converted resistivity and normal temperature.

Left up zone: Shows initial resistance average value, resistivity average value, converted normal temperature resistance average value, converted normal temperature resistivity average value.

Left down parameters zone: Set three output current range, test time, resistance up-limit alarm value, being tested resistance length and section area.

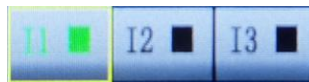

Right down test zone: (1) three buttons stands corresponding each test data of three current range. Green stands for having data, black shows no data. Selected button (yellow frame) shows the test data of selected current range. (2) Message box: brief description, remind operating process. (3) System date and time. (4) Order button: Function, Setting, Test, Help.

Click“Function”button and“Help”button, shows popup menu for each detail operating.

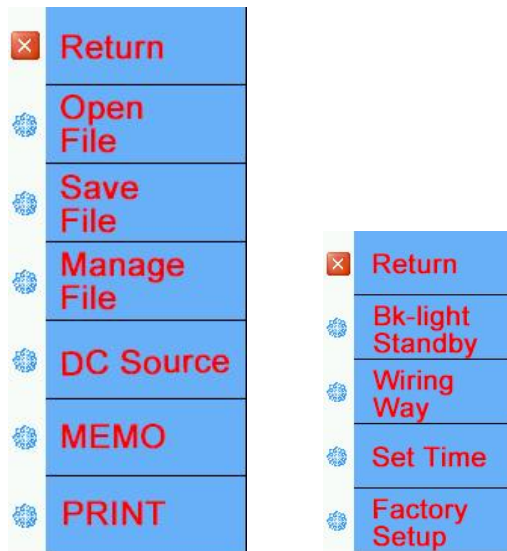

Picture 5, menu item

(3)Set test parameters In main interface, press“Setting”button enter parameters interface.

See picture 6:

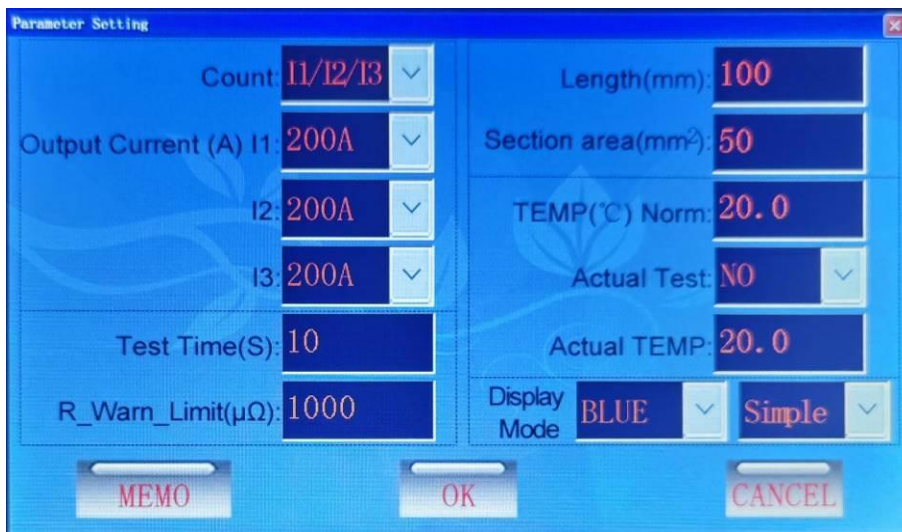

Picture 6, Parameters setting interface

Do parameters' settings through drop-down menu by digital key board, Press“OK”button to save parameters in system, not impact by power off and re-open.

Current test times and output current: In the interface to set “current times”stands for different current range to calculate average value, can select [I1], [I1/I2], [I1/I2/I3]. [I1] is only for output I1 current test. [I1/I2] is for output I1current test first, and then output I2 current test. I1/I2/I3 is for output I1 current test first, then output I2 current test, finally output I3 current test.

Test Time: Set from 1 to 9999s.

Resistance up-limit: can set limit from 0-999999μΩ. When being tested resistance is not over up-limit, test status is“OK”; When being tested resistance is over up-limit, test status

shows“over-limit”; If current and voltage cable connect wrong, then shows invalid.

Length and section area: set the length and section area to calculate resistivity.

Temperature settings: to convert resistance value in actual temperature to the normal temperature resistance value. If select“stop”, actual temperature is preset temperature; If select customized temperature sensor and select“start”, actual temperature is real in testing.

Background selection and traditional and simplified forms of Chinese characters: Set screen color to image-text blue and black. If select“simplified”, then do not show converted data in main interface.

Test remark: Press“test remark”button to enter picture 7 page,

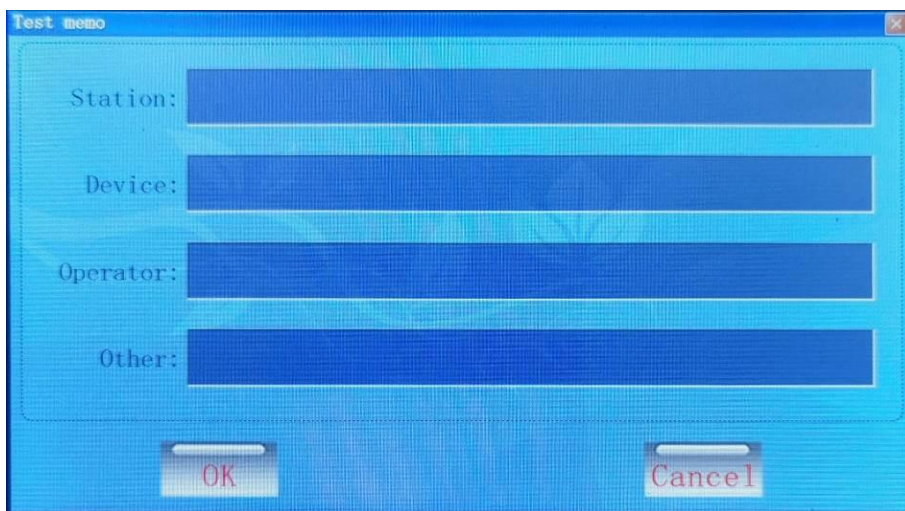

Picture 7, test remark interface

In the interface, input information such as settings related, equipment related, person related and remark of being tested resistance, store and print with test data.

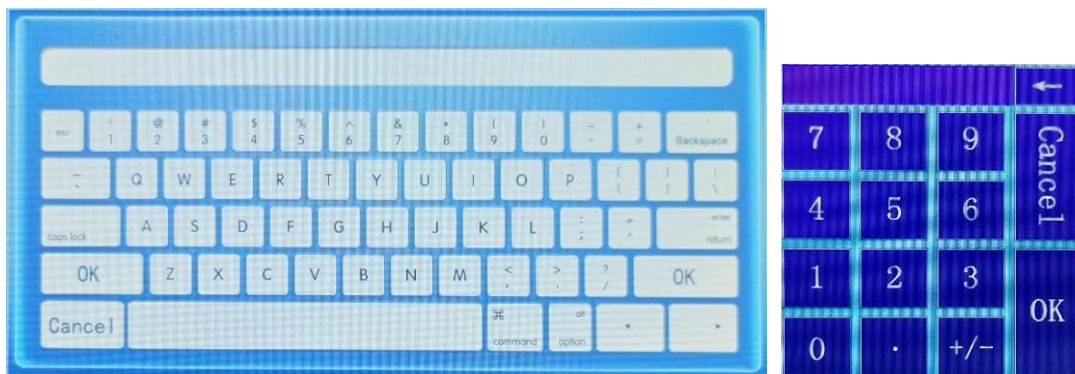

Picture 8, EN & CN and digital keyboard

(4)Test resistance

Before test, make sure test cable and GND cable is connecting tight. In main interface, press“test”button to do test. Automatically stop test when it is finished. Also

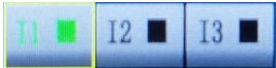
press“stop”button to interrupt test. Once finish the test, click  to

switch and look up test data.

(5) Data storage

In main interface, press“save”menu of“function”menu, save test data and take real time as data record name.

(6) Data printing

In the main interface, Press“print”menu of“Function”menu to print out real test data. Thermal paper can be used for data printing on one side, can not on the other side. Only around three months recording on the thermal paper, not for long time storage.

(7) Document open and management

In the main interface, press “open”menu of“function”menu to enter interface as picture 9,

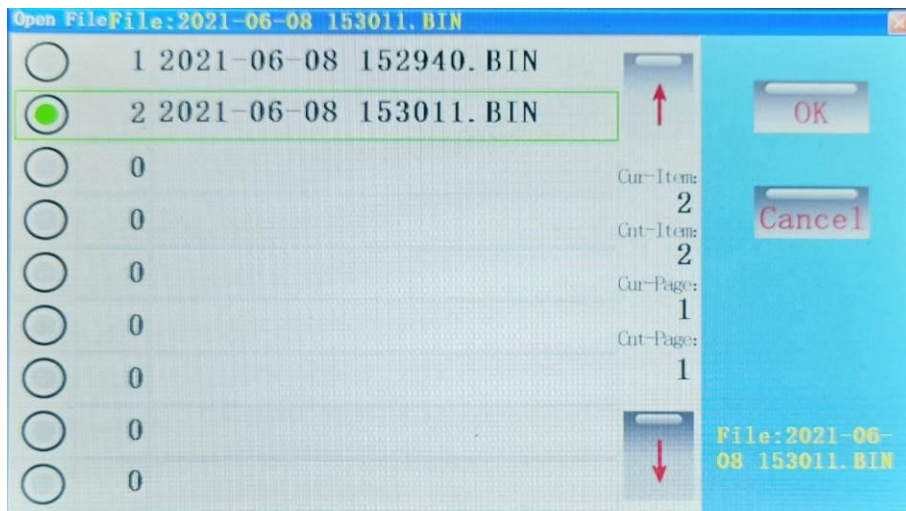

Picture 9

The interface shows page number, total number and selected item, document name is called by real time. Click up-page and down page to look up, press ‘ok’ to open the selected document.

After open the document, test data in the document would cover present test data, and re-calculate and show the test data.

In the main interface, press “File”menu of“function”menu, to enter interface as picture 10,

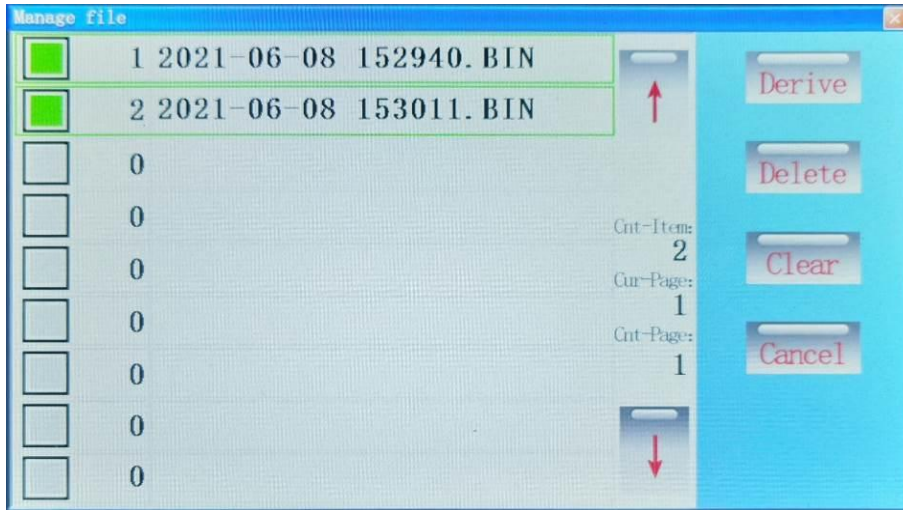

Picture 10

Press "delete" to remove selected file, press "clear" to clear out all files. Insert U disk, then show 'U disk inserted' reminding, press "export" to convert file to WORD inside U disk. Already exported file shows "*UP" means not be re-exported, see picture 11,

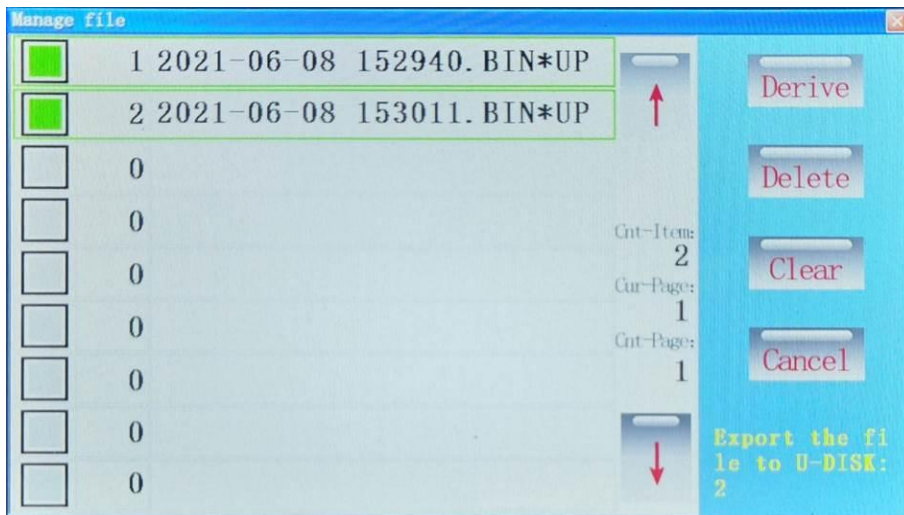

Picture 11

File named by test real time and store as picture 12,

```

The Result Data
Start time:2021-06-11 092007.
Count:I1
Test Time:10.
R Warn_Limit: 2000
Length:100.
Section area: 50
Actual TEMP:NO.
-----
          I1      I2      I3.
STATUS   Normal  Normal  Normal.
  R 375.94
  U 38.79
  I 103.18
  SR 187.97
  TEMP 20.0
NormTEMP 20.0
  Tran R 375.94
  Tran SR 187.97
Avg R: 375.94
Avg SR: 187.97
Tran Avg R: 375.94
Tran Avg SR: 187.97
-----
Unit:R-  $\mu\Omega/m\Omega$  U-mV I-A.
SR-  $\mu\Omega \cdot mm/m\Omega \cdot mm$ 
Length-mm Section area-mm $\times$ 2 TEMP- $^{\circ}C$ .
    
```

Picture 12

Convenient for data storage, generation and sharing.

(8) Help menu function

Background brightness: modify background brightness, idle time and brightness of idle.

Cable connection diagram: guide and train onsite operating of cable connection.

Time settings: calibrate system time of tester.

Maintenance: Factory enter the page to key in password to do maintenance. Unser is not allowed enter it.

Related picture 13~14,



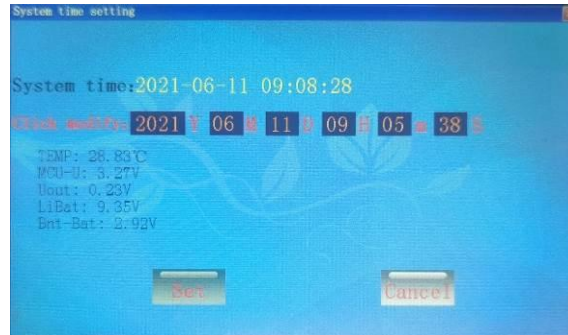

Picture 13

Picture 14

VII.DC Constant Current Source Function

Can output current from 0 to infinite, internal step-up current test, equal to powerful DC constant-current source. Open “DC power”of “function”menu, see picture 19,

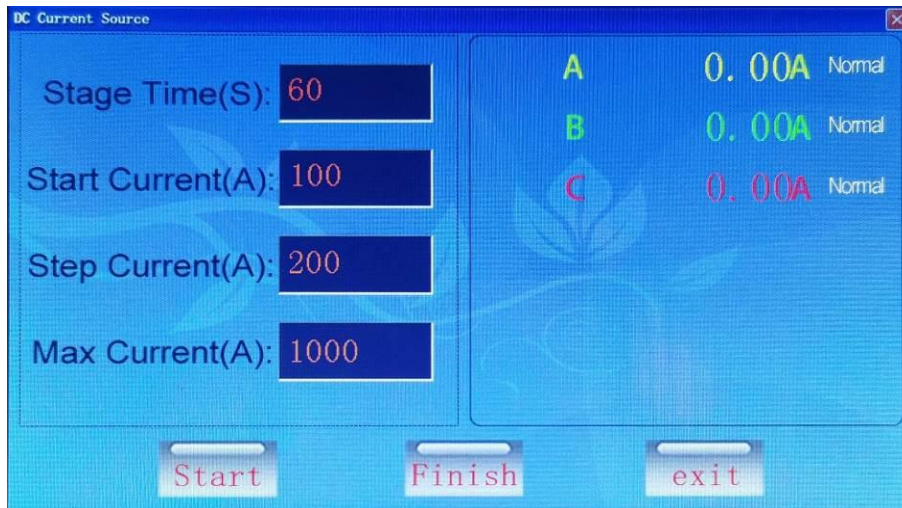

Picture 19

Please set “periodical time”, “initial current”, “step current”, “max current”. Press “start” to realize periodical step-up current process. Firstly take “initial current” value output, keep timing to “periodical time” value, then add “step current” value output. Again keep timing to “periodical time” value and then add “step current” value output, repeat the cycling process to output current over “max current” value, finally finish the whole output current. In the test, can press “interruption” to stop whole test process.

VIII.Mobile Phone Control and Data Transfer (BT communication)

Install android blue-tooth APP(BTAPP.apk), , open the APP, see the picture 20~22

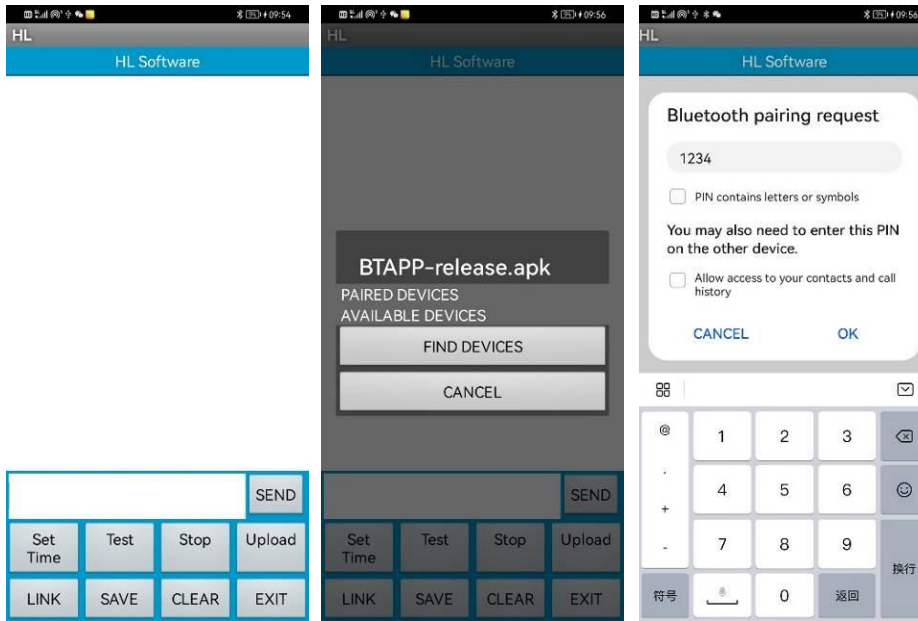

Picture 20

Picture 21

Picture 22

Firstly click“connect”to search blue-tooth device, find“BTHL” then click it, key in password“1234”to connect it.

Connect blue-tooth successfully, then use APP to control tester. Like click“test”,“stop”,“upload”,“store” etc. after“upload”and“store”, picture 23~25 shows,



Picture 23

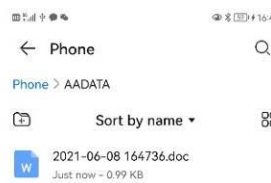

Picture 24

File is stored in“data”catalog, and named by real test time for convenient storage, report generation and data sharing.

IX.Failure Analysis and Trouble Shooting

Symptom	FA	Trouble shooting	Remark
No display after power on	1 Power not connected or open	Check fuse or switch broken	Must use same type fuse, do not other type instead
) Fuse not fit well or open	Change new fuse or re-insert fuse	
Output current can not reach to rated current	Test path too long caused section area too small	Change big section area cable	
No current output) Equipment connection open	Check tester	
	Test circuit is open	Check test circuit carefully	

X.Attentions

- 1.Before power on, please contact current output end and being tested object.
- 2.Tester should be stored and placed in moisture-proof, dry and clean room.
- 3.Do not disassemble and revise the tester, or else caused electric shock risk.
- 4.Do not repair and self-revise, or else it is not the guarantee period.
- 5.Do read the user manual in details before using.

XI.Transportation and Storage

■Transportation

While transport product, recommend use our provided package wooden case and damping stuff, in case of damage during delivery, loss and other impact.

If not use wooden case, not allow to stack storage. Max stacking height is 2 layers if use our wooden case.

Tester's panel board is up placement in transportation.

■Storage

Tester must be placed in dry, clean, ventilated and no corrosive gas room. Can not stack storage if no wooden case protection.

In storage, the tester's panel board should be up placement, for prevention of moisture, please put moisture-proof stuff underneath product.

XII. Packing List

No.	Item	Qty
1	Red current line	1
2	Black current line	1
3	Power line	1
4	ground lead	1
5	Red black current line	2
6	Print paper	1
7	Fuse pipe	2